

- A. Power supply 230/400V input.
- B. Pump supply output.
- C. Low level output.
- D. Main alarm output.
- E. External on/off control input.
- F. Level probes input.
- G. Current transformer input.
- 1. Low level.
- 2. Pump running.
- 3. Overload setting.
- 4. Underload setting.
- 5. Restart time setting.
- 6. Main alarm.

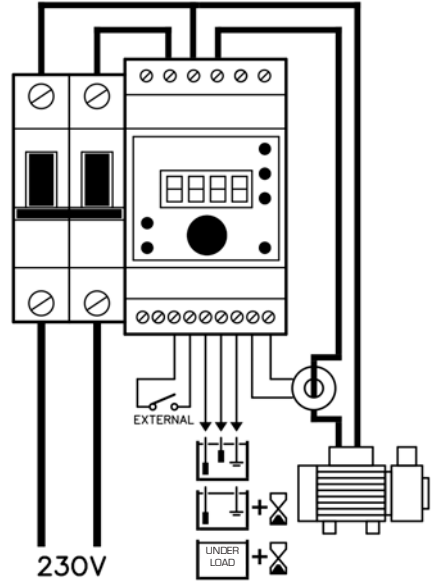

Single-phase basic diagram  
(three-phase pump by contactor)

<b>Power supply</b>	230/400Vac - 50/60Hz
<b>Pilot lights (LED)</b>	Low level, Pump running, Maximum current, Minimum current, Restart time, Main alarm
<b>Protections</b>	Overload, Underload, Phase loss, Excessive starting frequency
<b>Displayed information (4-digit LED display)</b>	Pump consumption, Maximum current, Minimum current, Restart time, Alarms
<b>Pump output</b>	12A in 1-phase (up to 40A in 1/3-phase with a contactor)
<b>Low level output (LEVEL)</b>	230/400Vac - 5A maximum
<b>Main alarm output (ALARM)</b>	230/400Vac - 5A maximum
<b>Maximum current setting</b>	Auto - 0.6...40A (trip in 7 s)
<b>Minimum current setting</b>	OFF - 0.5...40A (trip in 4 s with 20 s starting delay)
<b>Restart time setting</b>	OFF - 3...240 min
<b>Maximum terminal cross-section</b>	4mm <sup>2</sup> (power) / 2,5mm <sup>2</sup> (control)
<b>Width/Weight/IP/Temperature</b>	3 modules (52,5mm)/210g/IP20/-10°...+55°C

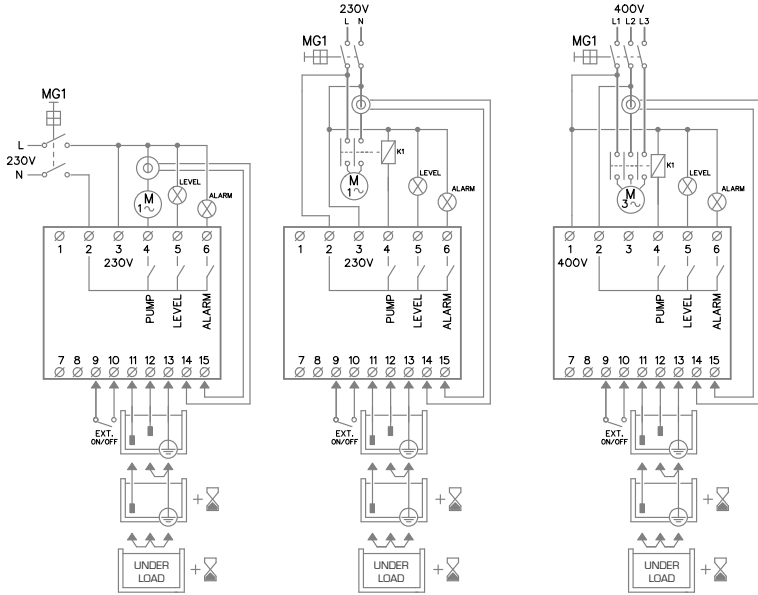

WELLS

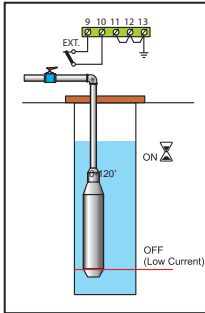
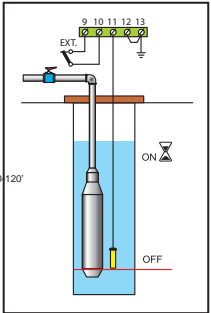
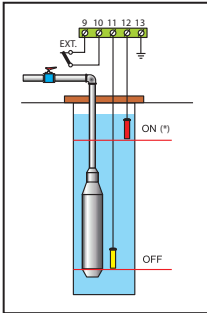

LIFTING STATIONS

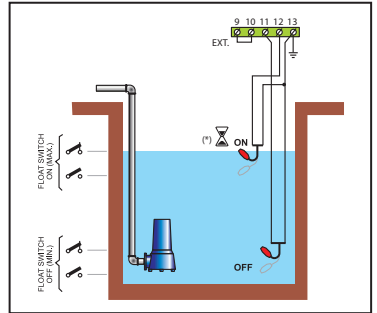

BOOSTER SETS

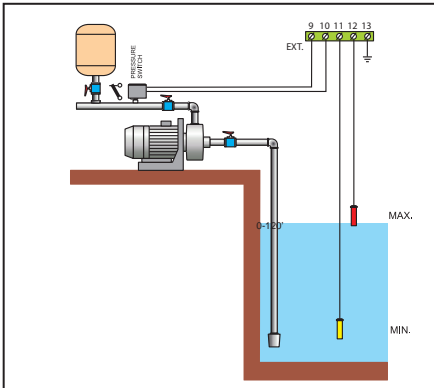

WELLS & TANKS CONTROL

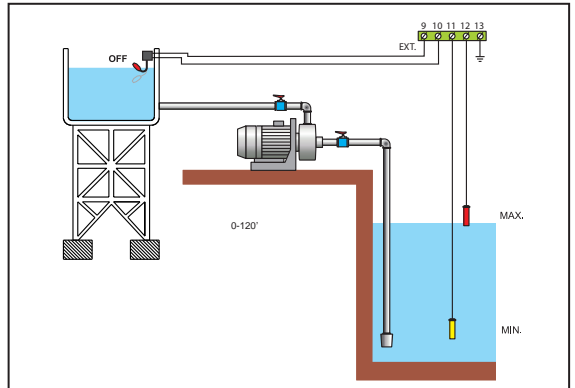

(\*) Set to "OFF" recommended / Se recomienda ajustar a "OFF" / Réglage à "OFF" recommandé

# set-up menus

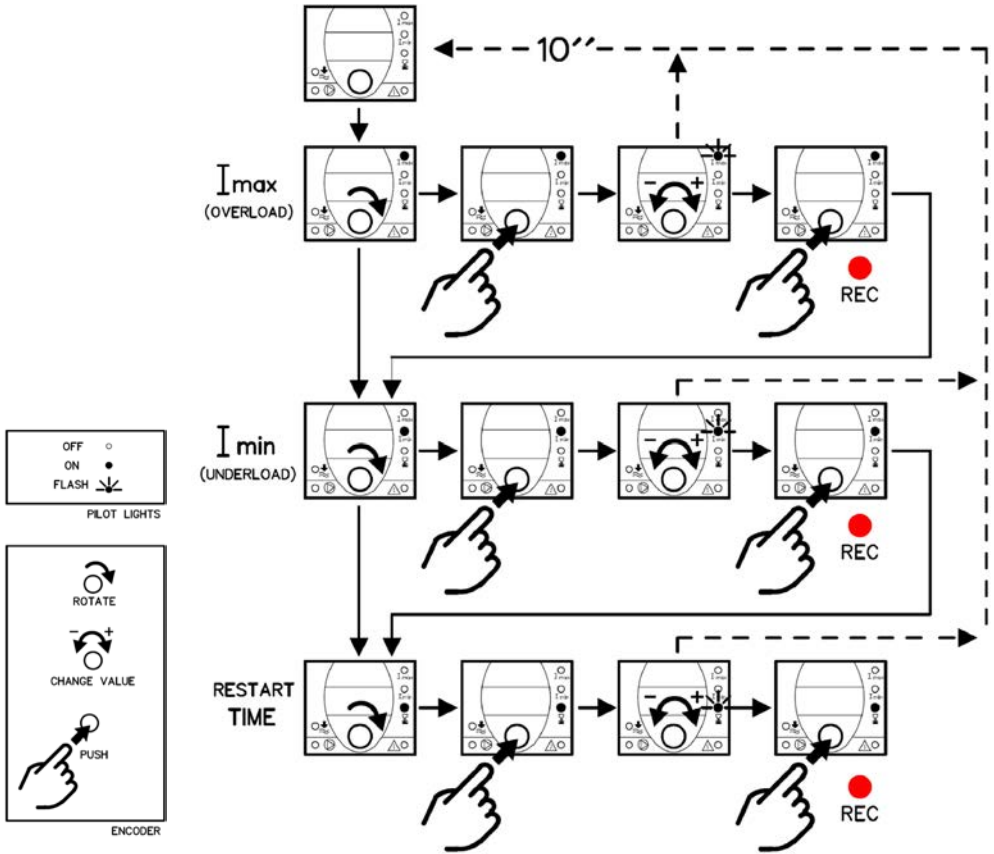

## I<sub>min</sub> setting for wells without probes

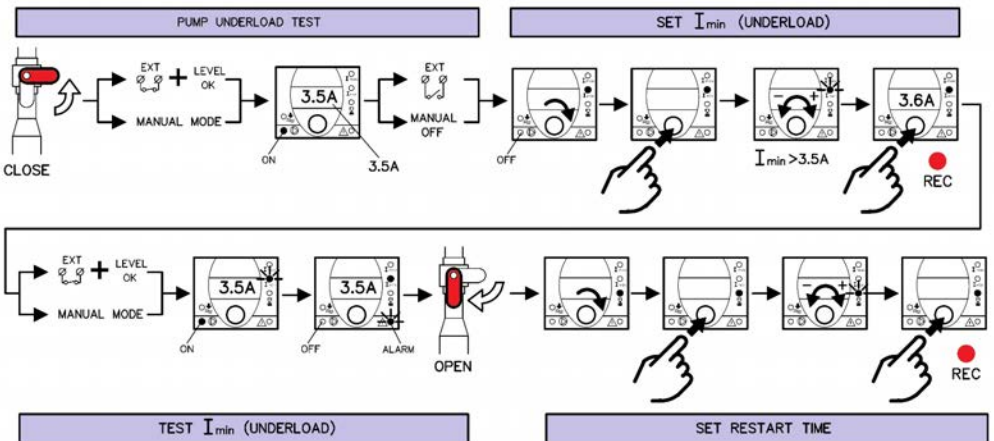

## auto-tune

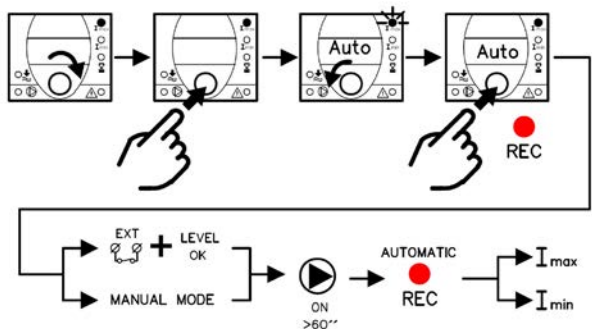

## manual mode

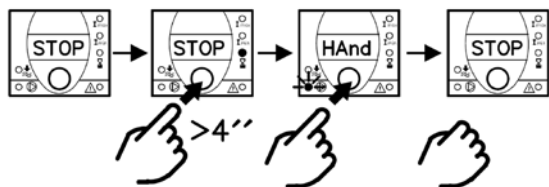

## reset

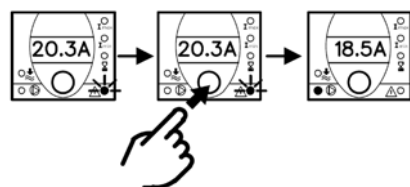

## status

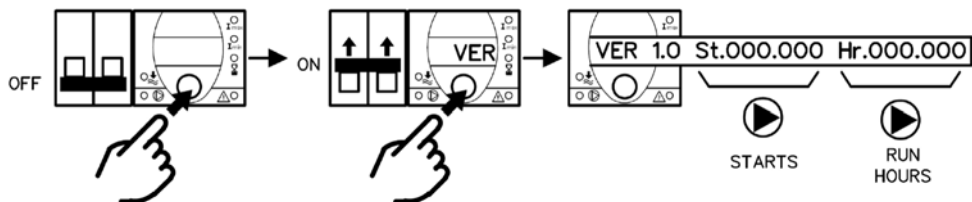

## high frequency detection

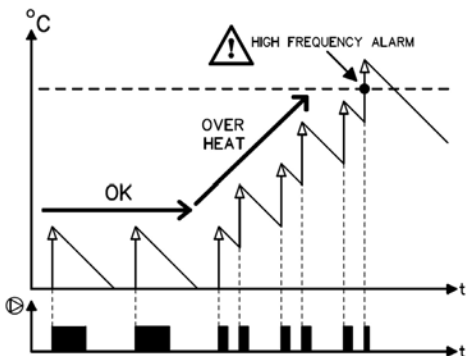

## dimensions

